

ネウロイ X-21

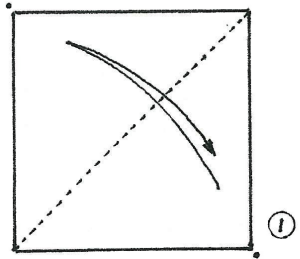

①

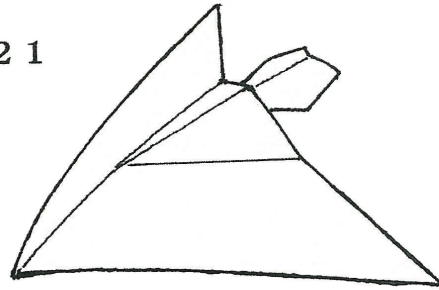
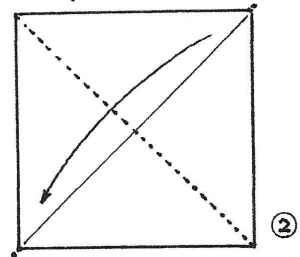

②

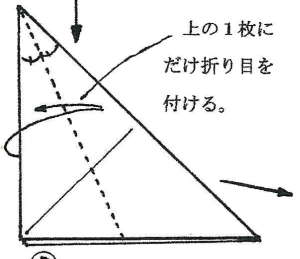

③

③に同じく。

④

③④の折り目で引き寄せ折り。

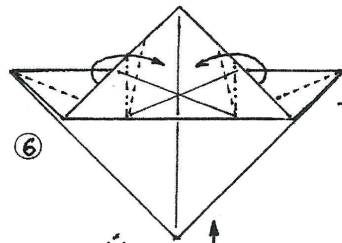

⑥

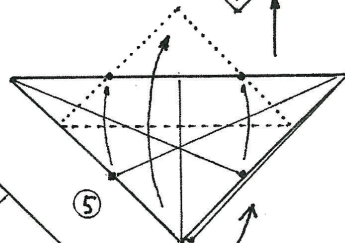

⑤

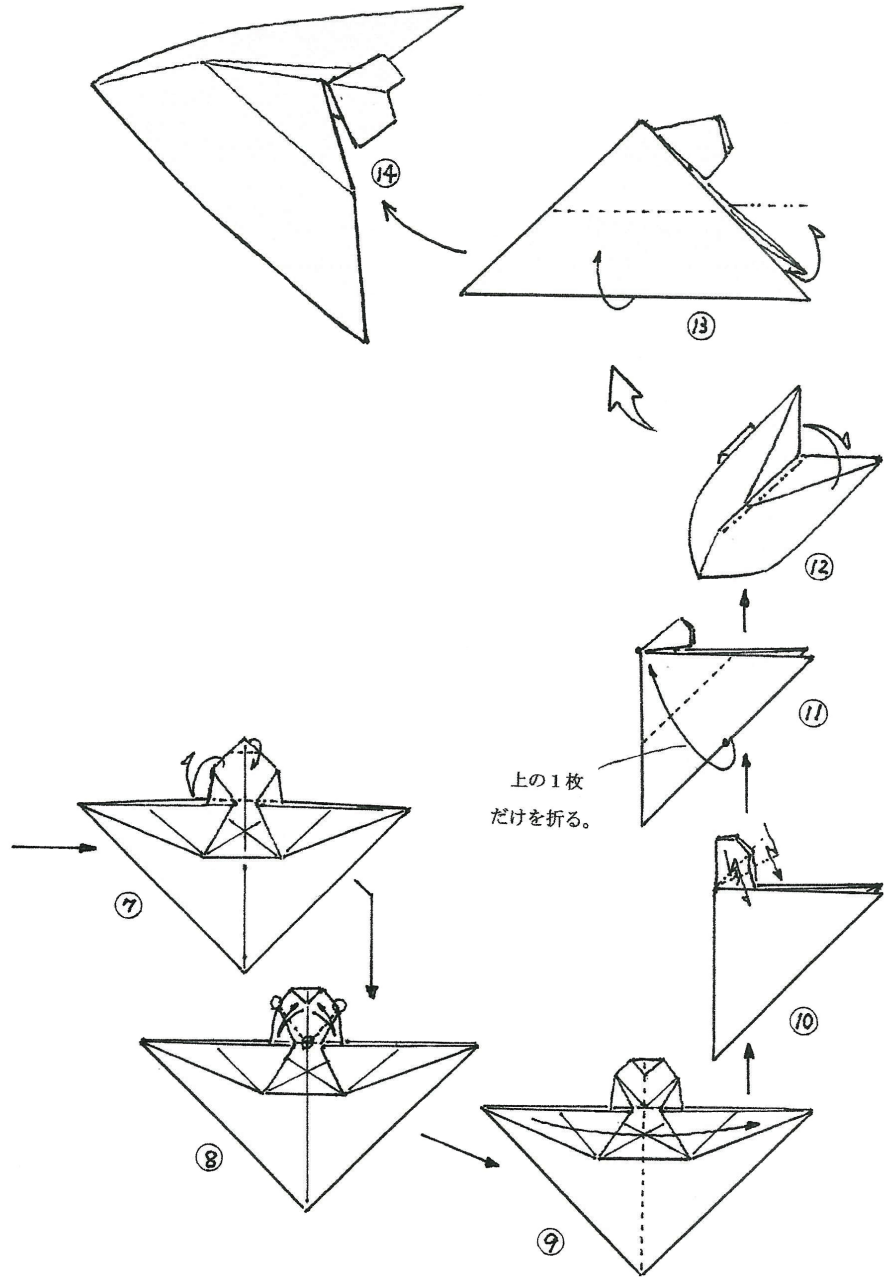

⑭

⑬

⑫

⑪

上の1枚  
だけを折る。

⑩

⑦

⑧

⑨